

ORTHOPANTOMOGRAPH™ OP 3D™

Imaging innovations in one device

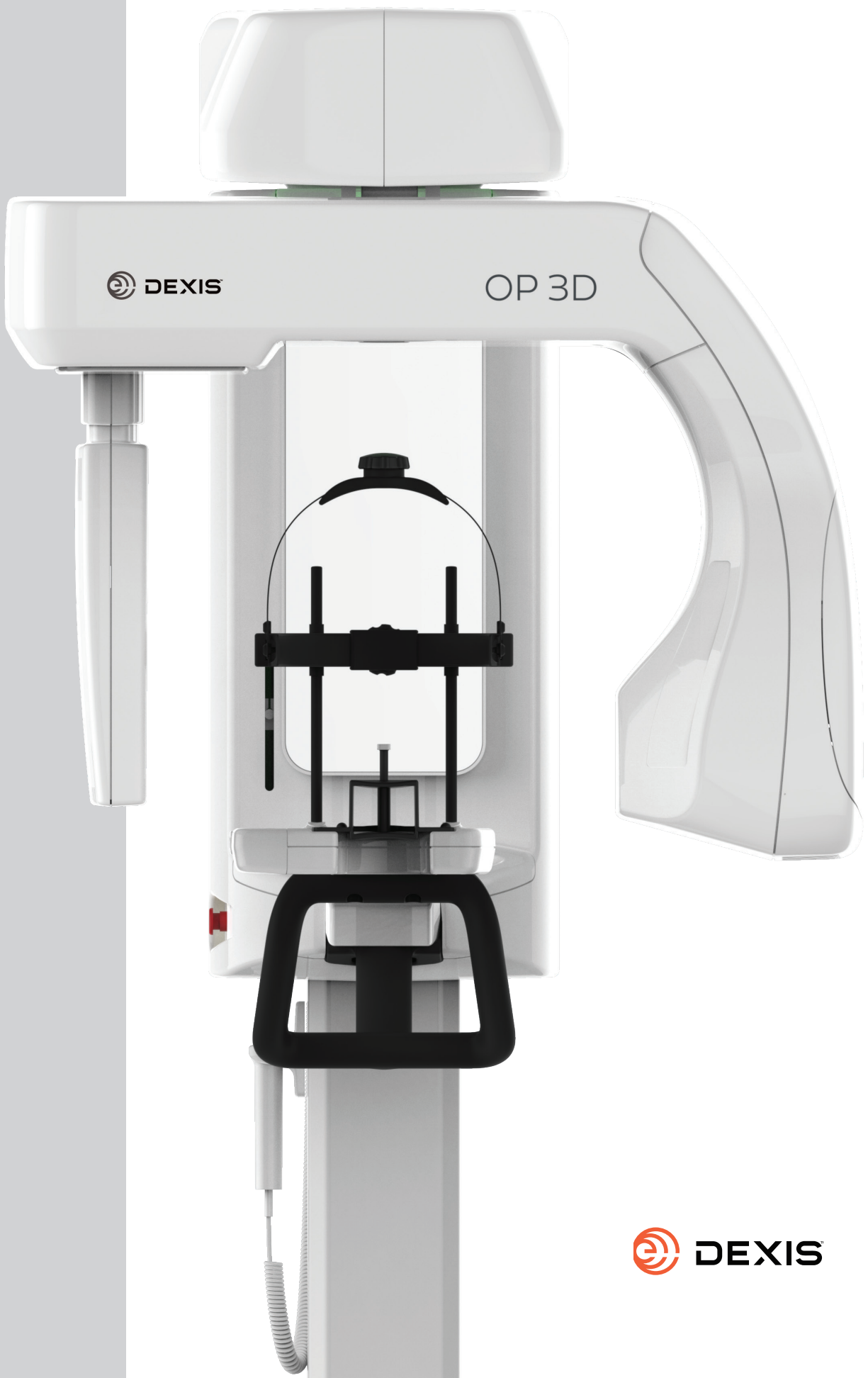

ORTHOPANTOMOGRAPH OP 3D



The DEXIS OP 3D is a unit designed for advanced dental imaging needs. It is a complete X-ray platform that provides easy-to-use features throughout the entire dental imaging workflow. The versatile panoramic, cephalometric and 3D programs offer image excellence for a variety of users ranging from general dental practitioners to maxillofacial surgeons.

The OP 3D system is a member of the legendary ORTHOPANTOMOGRAPH product family; it respects the legacy, yet renews the meaning of image quality, efficiency and ease-of-use.

3D images provide valuable information vital to diagnosis and optimal treatment planning. Evaluation of different morphologies is easy as the region of interest can be viewed from all directions.

- Implantology
- Endodontics
- Impactions
- TMJ
- Trauma
- Periodontics

Leading the way through the decades

For more than 60 years, the name of ORTHOPANTOMOGRAPH system has stood for ultimate reliability and clinically correct maxillofacial imaging.



Sustainable green solution

The OP 3D imaging unit replaces lead typically used for tubehead radiation shielding designs with a more ecological and environmentally friendly alternative that provides equivalent radiation attenuation. Plus, the power save feature of this system reduces overall energy consumption of the practice.

Designed for efficiency

Every feature of the OP 3D system is designed to increase practice efficiency. Preparing the unit for a scan is fast with an intuitive patient positioning system and graphical user-interface. Imaging protocols are optimized for practice workflows.



ORTHOselect™ for optimized workflow



The desired imaging area can be selected intuitively with the ORTHOselect user interface. Selections can be made as individual teeth, an entire upper or lower jaw, or TMJ. The optimum field-of-view (FOV) is set automatically based on the selection.

New level of control and flexibility

With the OP 3D system the FOV location can be controlled easily and accurately. SMARTVIEW™ 2.0 user-interface offers two-dimensional scout images prior to the actual CBCT examination. Users can verify the exact FOV location with the ability to adjust automatically based on the selection. This limits the need for retakes and can help lower dosage and follow ALARA (As Low As Reasonably Achievable) radiation protocols.



Customized FOVs with SMARTVIEW 2.0

With the OP 3D system, the number of FOV sizes is practically unlimited. SMARTVIEW 2.0 user-interface enables choosing the most optimum FOV size for the clinical need as the FOV height can be freely adjusted from the taken scout image.

QUICKcompose™ feature for fast image review

QUICKcompose feature is available for panoramic, cephalometric, and 3D modalities, and offers a quick preview of the captured image allowing for timely evaluation.

Tools for professionals

One size does not have to fit all. The OP 3D system offers efficient tools for optimizing the patient dose with its ability to allow the clinician to select the best resolution, FOV size, and region of interest.

Clearer images with MAR technology

To provide the highest level of image quality, the Metal Artifact Reduction (MAR) is readily activated with all the FOV sizes of OP 3D. MAR is optimized to aid in all cases ranging from endodontics and implants to maxillofacial imaging.

Noise reduction with EPNR filtration

The Edge Preserving Noise Reduction (EPNR) filter offers visible improvement as it both smooths away noise while retaining sharp edges and preserving valuable clinical details.

Variety of resolutions



Low Dose Technology scan (LDT) can be utilized in dose-sensitive cases as well as in control and follow-up scans where patient dose is to be minimized, or lower resolution is acceptable.



Standard resolution scan with optimized patient dose can be used for general diagnostics.

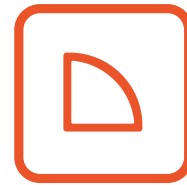

High resolution scan offers extremely sharp images for more detailed diagnosis.



Endo resolution scan with 80µm voxel size specially designed for endodontic applications. Endo resolution is available for the 5 x 5 FOV.

Clinical images

The OP 3D Fields-of-View are based on true clinical need.

FOV 5 x 5 cm

Optimized for endodontics, single-site implants, impactions and localized diagnostics.

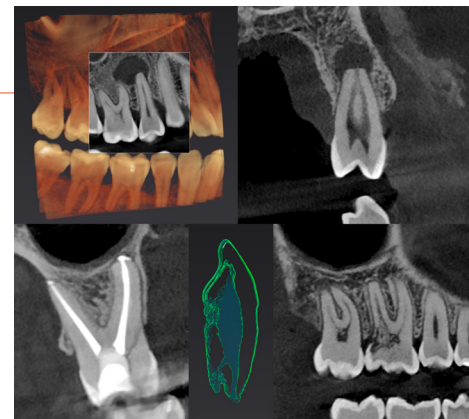
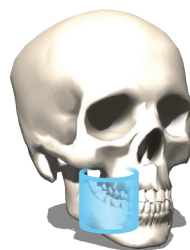

FOV 6 x 9 cm

Covers the complete lower or upper jaw with opposing occlusion.

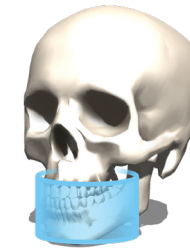

FOV 9 x 11 cm

Covers the entire dentition, including both lower and upper jaw as well a portion of maxillary sinus.

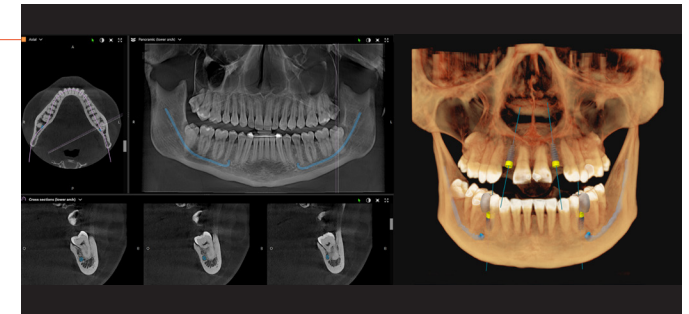

FOV 9 x 14 cm*

Encompasses the maxillofacial region and TM joints.

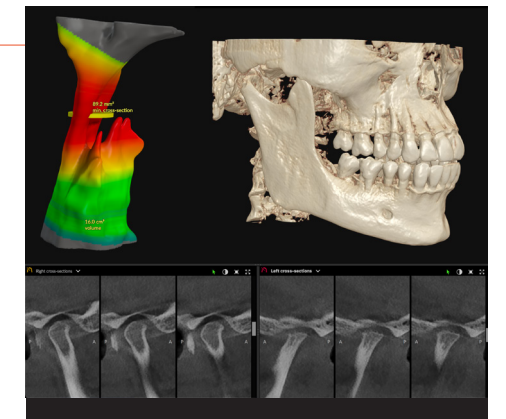

*Optional feature

DEXIS OP 3D

An upgradeable pan



The 9-second standard and pediatric panoramic scan times provide clear image definition, with fewer movement artifacts, as well as a lower dose to the patient.

Fully upgradeable

The OP 3D panoramic unit is completely upgradeable. Choose the addition of cephalometric imaging, or completely upgrade and choose to add 3D imaging to your practice for even more diagnostic options.

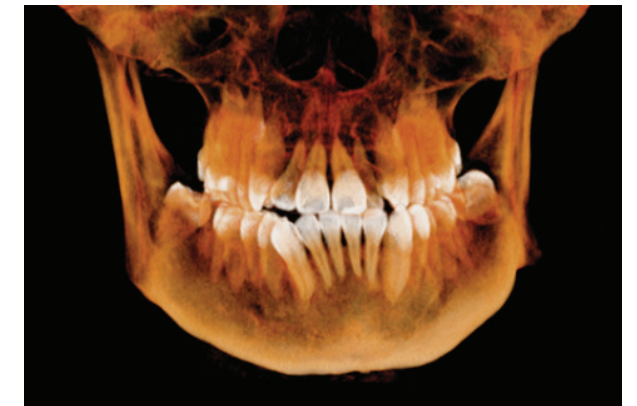
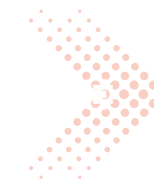
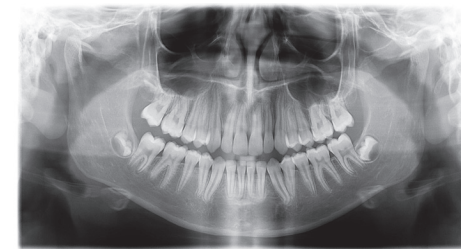

The first ORTHOPANTOMOGRAPH™ unit, introduced over 50 years ago, was a revolutionary ground breaker and pacesetter for dental panoramic X-ray imaging.

Today, with more than 60,000 units sold, the ORTHOPANTOMOGRAPH systems are regarded as the leading name and benchmark in the X-ray world.

2D panoramic

Standard and pediatric panoramic images, along with bitewing and lateral TMJ projections cover all the extraoral imaging needs of a busy practice.



9-Second scan time: The standard panoramic program provides a clear definition of the dental anatomy, including TMJs—in only 9 seconds.

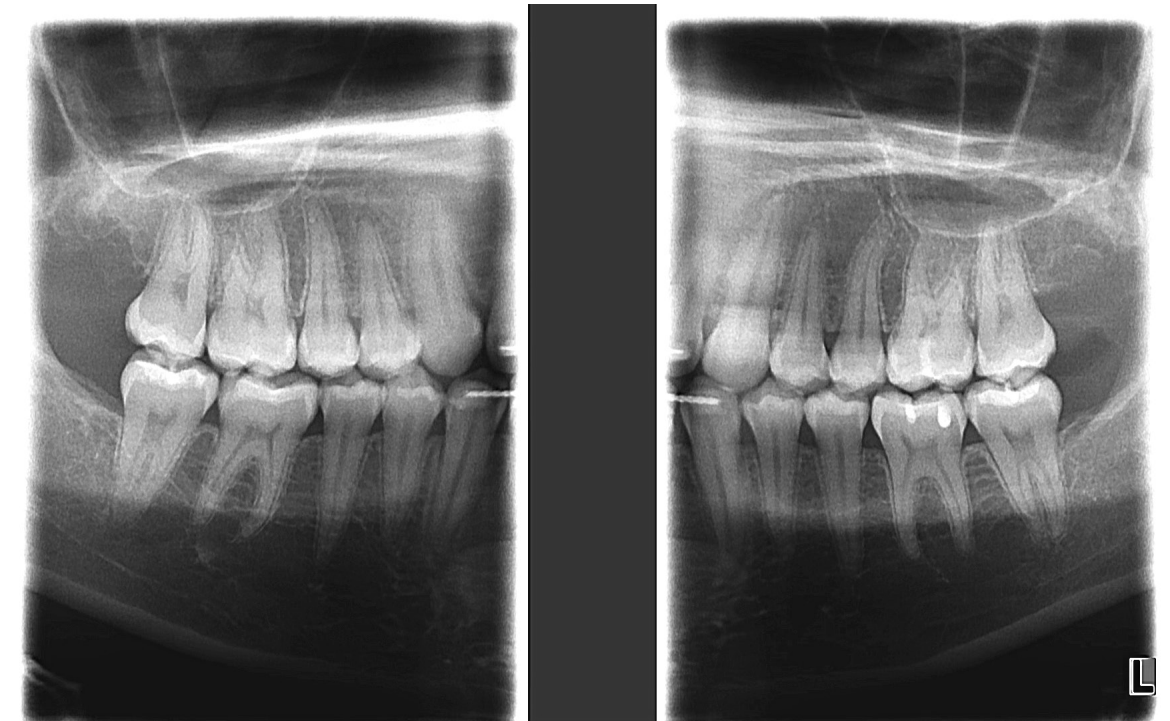

Bitewing-like view is a quick and easy alternative to intraoral bitewing imaging.



ORTHOfocus™ feature—sharp images automatically

With the ORTHOfocus feature, the optimum panoramic image layer is automatically obtained enabling forgiving patient positioning. The result is consistent image quality every time.

Choose your layer with multilayer pan

The multilayer panoramic feature optionally supplies five layers within one exposure with the same scan time and dosage as a single panoramic exposure. Select your optimum image layer to focus the panoramic curve on your diagnostic need.

CEPHALOMETRIC IMAGING

The innovative, patented ORTHOceph™ Plus design of the OP 3D system takes cephalometric imaging workflow to a new level. The OP 3D system provides needed protocols such as lateral and pediatric lateral projections with adjustable field widths, posterior-anterior (PA) projections and carpus imaging — with fast scan times and a minimal dose. All combined with an intuitive graphical user interface and automated sensor movements to enable smooth workflows.

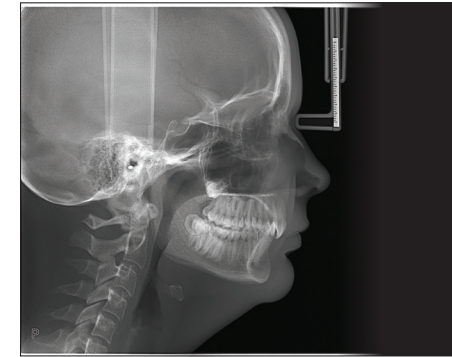

Lateral cephalometric images provide rich anatomical details with exceptional visibility of the soft tissue borderline.



Pediatric lateral images with reduced height allow one to minimize the dose.



PA cephalometric images offer great details — thanks to the powerful dedicated X-ray source.



Carpus imaging-information to determine patient age and growth.

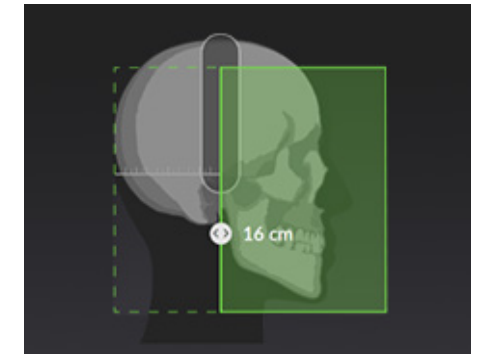

Lateral cephalometric programs for adult and pediatric patients with adjustable 16 to 26 cm fields width.

ORTHOceph plus design:

- Thanks to its patented design, the OP 3D system is by definition at the correct height for a CEPH image if a panoramic image has been taken first. Owing to the minimized needs for adjustments, workflows are easy and fast.
- A dedicated X-ray source for the cephalometric imaging, combined with advanced sensor technology, enables a high capacity and optimum imaging parameters resulting in clinically relevant results with minimal patient dose.



DEXIS—Dental imaging excellence

DEXIS brands are committed to providing the foundation so our customers can do more of what is important to them and their patients. Through product innovation, world-class service and exceptional support, DEXIS brands bring the best dental technology.

The known DEXIS quality is now available in an impressive product portfolio. We are proud to offer world-class imaging solutions and more.

Everyday, we are empowering clinicians to do more of what matters.



Technical specifications

2D / Panoramic

Image receptor	CMOS
Pixel size (sensor & image)	99 µm
Tube voltage	60–90 kV
Tube current	2–16 mA
Scan time	9 s
Image field height	147 mm
Imaging programs	Standard, Segmented, Pediatric, Lat TMJ, Bitewing

3D / CBCT

Image detector	CMOS
Image voxel size	80–400 µm
Tube voltage	95 kV
Tube current	2–12.5 mA
Scan time	10–20 s
Image volume sizes (H x Ø)	5x 5, 6x 9, 9x 11, 9x 14 cm (optional) Volume height and location are adjustable through SMARTVIEW™ 2.0 interface.

2D / Cephalometric

Image receptor	CMOS
Pixel size (sensor & image)	99 µm
Tube voltage	60–95 kV
Tube current	2–14 mA
Scan time	10.5 and 8.1 s
Image field height	180–223 mm
Image field width	160–260 mm
Imaging programs	Lateral and Pediatric Lateral with an adjustable field width, Posterior-Anterior (PA), Carpus*

Others

Tube focal spot	0.5 IEC 336 (IEC 60336/2005)
DICOM** support	Available as a software option.

Easy wheelchair accessibility. The device meets the RoHS Directive 2011/65/EU without any exemptions mentioned in Annex IV. Details on the system requirements can be found on our Internet pages or can be requested at technical service.

*Carpus imaging with optional holder.

**DICOM is the registered trademark of the National Electrical Manufacturers Association for their standard publications on the digital exchange of medical data.

Dimensions

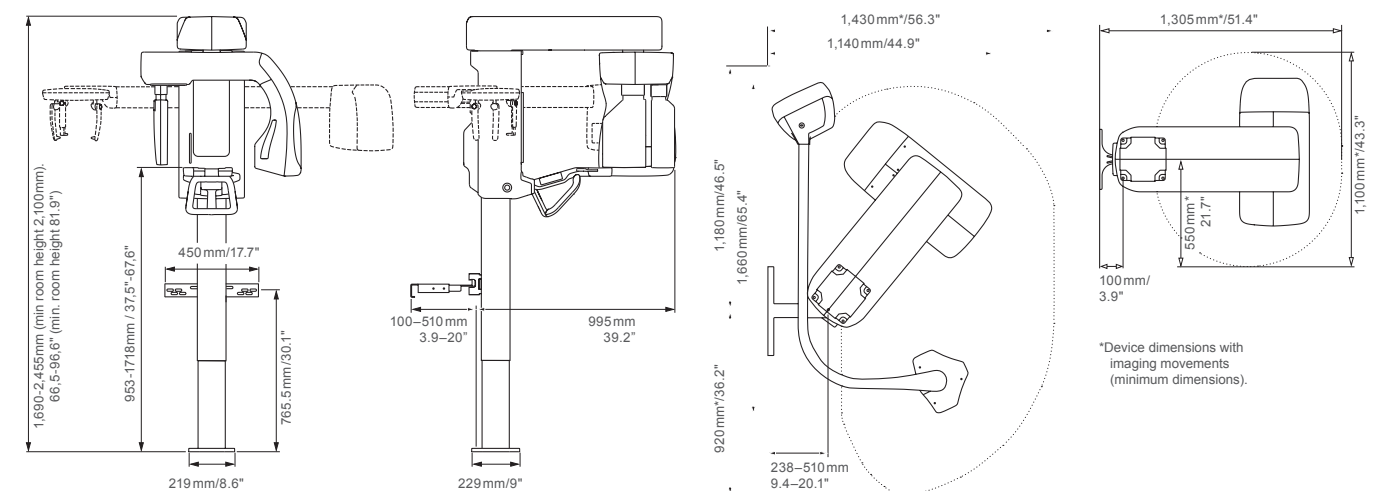

*Device dimensions with imaging movements (minimum dimensions).

About DEXIS

DEXIS innovation is nothing new. After all, our recognized, trusted products are built on over 200 years of dental imaging expertise, combining leading brands including i-CAT™, Gendex™, Instrumentarium, SOREDEX™, and NOMAD™ Pro 2. Today, over 150,000 offices trust DEXIS products around the world.

DEXIS now includes a full portfolio of products including CBCT and intraoral scanners, our legacy digital sensors and handheld x-ray system and DTX Studio™ Clinic, the next generation software. This complete digital solution works seamlessly together as well as with other systems to enhance the way you diagnose, plan, and treat patients in your practice. Elevate your patient outcomes with greater confidence — across the patient journey. With DEXIS proven solutions, you'll be able to treat patients from consultation to diagnosis to treatment to surgery and deliver appliances, all with the efficiency that you come to expect with the DEXIS brand you already know.

DEXIS | 450 Commerce Drive | Quakertown PA 18951 | USA | 1-888-88-DEXIS | DEXIS.com

The products, equipment and services illustrated and described in this brochure reflect knowledge at the time of printing. Dental Imaging Technologies Corporation accepts no liability for any deviation from the illustrations in terms of color or shape, or any errors or print errors, and retains the right to make changes to the brochure at any time. Full or partial reprinting is only permitted with permission from Dental Imaging Technologies Corporation. For indications for use, please visit: DEXIS.com

Dental Imaging Technologies Corporation reserves the right to make changes to specifications and features shown herein, or to discontinue the product described at any time without notice or obligation. Contact your local authorized representative for the most current information. Manufactured by Palodex Group OY, Nahkelantie 160, FI-04300 Tuusula, Finland. Tel. +358 10 270 2000.
© Dental Imaging Technologies Corporation. All rights reserved. DX00304/RevB